

Cherchez-vous quelque chose de spécial? Nous pouvons vous aider!

PROFILÉ SPÉCIAL

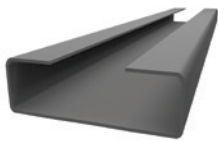

BARRE EN "Z"

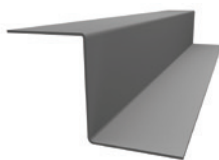

COUVERT DE PARAPET



TÔLE EN LANIÈRE

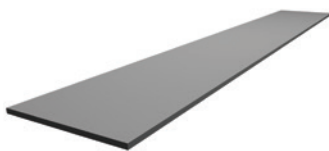

PROFILÉ OMEGA



ANGLE

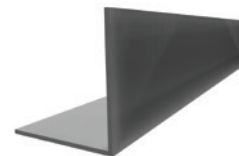

CAPUCHON DE FAÎTE

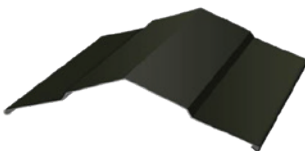

BANDE DE DÉPART



ARRÊT À GRAVIER



DÉVIATEUR D'EAU

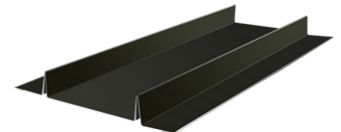

FAITE UN DESSIN



PRENEZ UNE PHOTO



ENVOYEZ-LA AU REPRÉSENTANT
BAILEY DE VOTRE LOCALITÉ



Profilés spéciaux disponibles en plusieurs couleurs, épaisseurs et longueurs

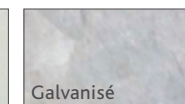
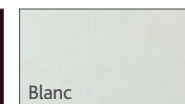
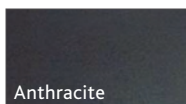
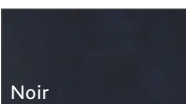

**Les couleurs peuvent différer légèrement des illustrations*



BON DE COMMANDE POUR PROFILÉ SPÉCIAL

www.bmp-group.com/fr



Client : _____ Téléphone : _____ Courriel : _____

Quantité : _____ Longueur : _____

Protection : G40 G60 G90

Couleur : Noir Anthracite Café/Cacao Brun Commercial Blanc Galvanisé

Épaisseur (surface peinte): 30 GA 28 GA 26 GA

Épaisseur (surface non peinte): 25 GA 20 GA 18 GA 16 GA 14 GA 12 GA

Quel est l'utilisation du profilé? _____

CROQUIS

* Indiquez clairement les angles, longueurs et cotés colorés sur votre dessin. Référez-vous à l'exemple.

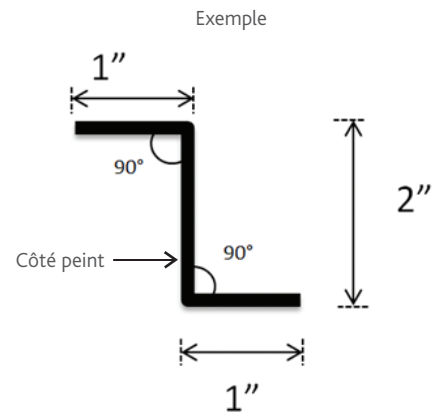
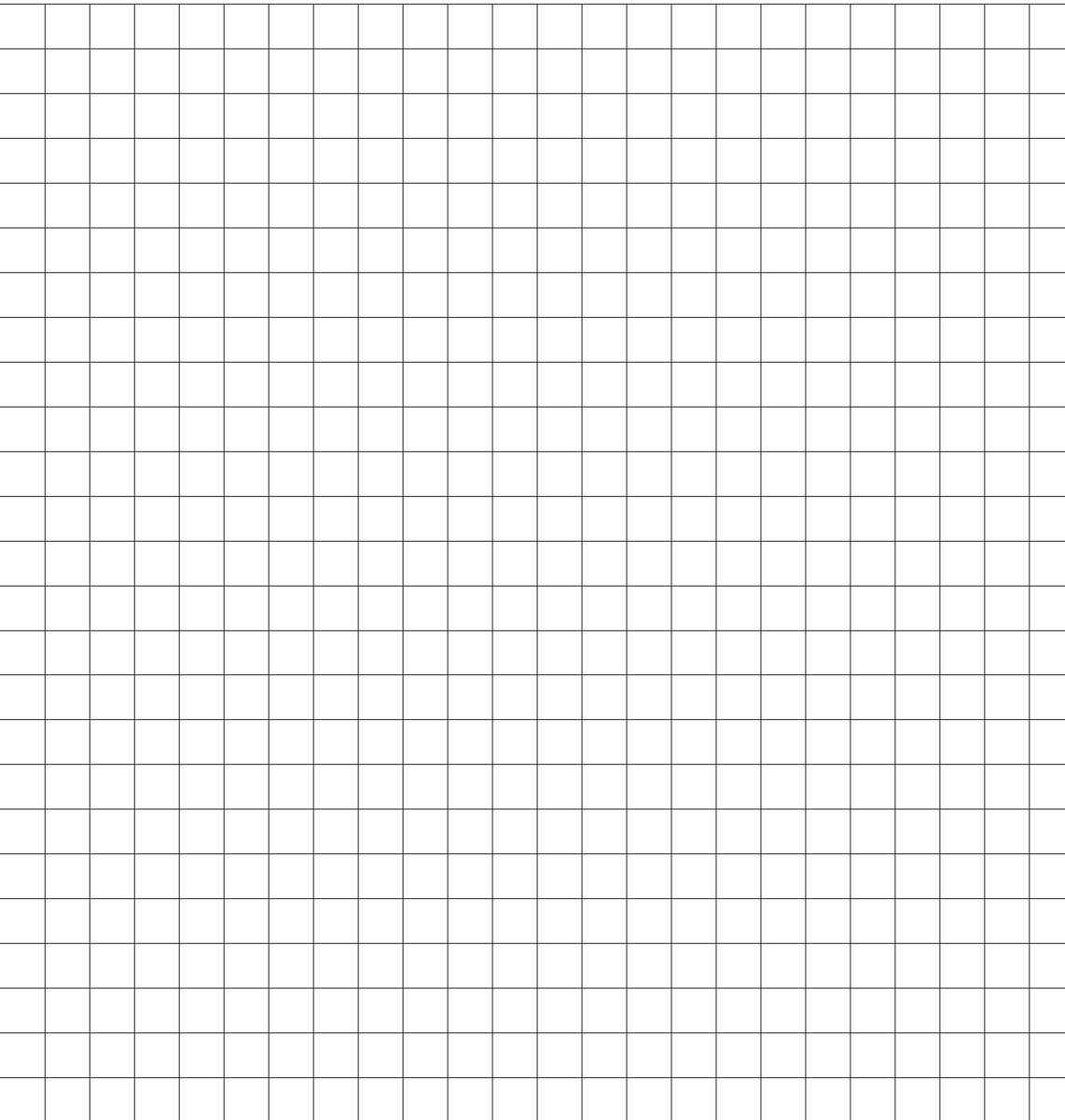

MONTREAL
Tel. 800-263-3455

TORONTO
Tel. 800-668-2154

CALGARY
Tel. 800-665-2013

EDMONTON
Tel. 800-563-1751

VANCOUVER
Tel. 800-818-2666

