

# CORNER-BACK DRYWALL CLIP

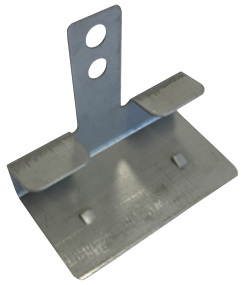

The **BAILEY CORNER-BACK DRYWALL CLIPS** eliminate wood or steel stud backup at 90° corners and ceilings. Corner-back clips make drywall installation and repair easier and faster.



## BENEFITS

- Eliminates uninsulated studs at corners and partition intersections which reduces thermal loss
- Corner-back clips reduce energy consumption
- Eliminates ceiling back-up members
- Easily adjusts for framing inaccuracies up to the width of the stud
- Reduces costly callbacks due to ceiling or partition separation from truss uplift
- Produces hard-fastened corners by attaching intersecting wallboards to a common stud

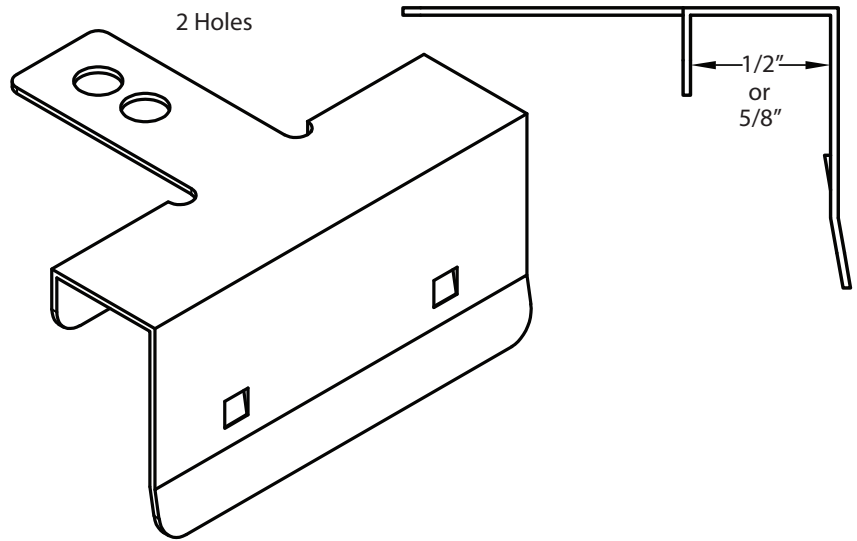

Corner-back clips are manufactured from galvaneal cold formed steel. Corner-back clips are available in two sizes to accommodate the attachment of 1/2" or 5/8" drywall. A fastening tab on the side of the clip provides for easy installation.

Bailey Corner-back clips are used for interior, load-bearing and non load-bearing wall assemblies in buildings of light-frame construction.

PRODUCT	DESIGN THICKNESS (in)	COATING	DISTANCE BETWEEN CHANNEL FLANGES (in)	LENGTH (in)	HEIGHT (in)	DEPTH (in)
Corner-back Clip 1/2	0.028	Galvaneal	1/2"	2	1-9/16	1
Corner-back Clip 5/8			5/8"			

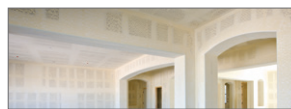

[sales@bmp-group.com](mailto:sales@bmp-group.com) | [www.bmp-group.com](http://www.bmp-group.com)

# CORNER-BACK DRYWALL CLIP

## QUICK AND EASY INSTALLATION

Corner-back clips are spaced a maximum of 16 inches o.c., within 2 inches of each unsupported drywall corner.

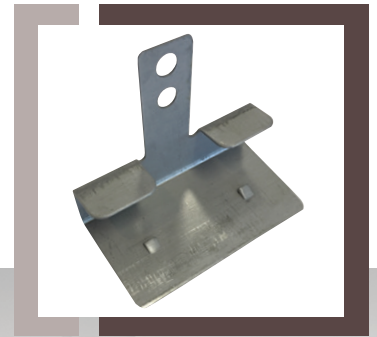

**A** The clips are applied to the edge of the drywall.

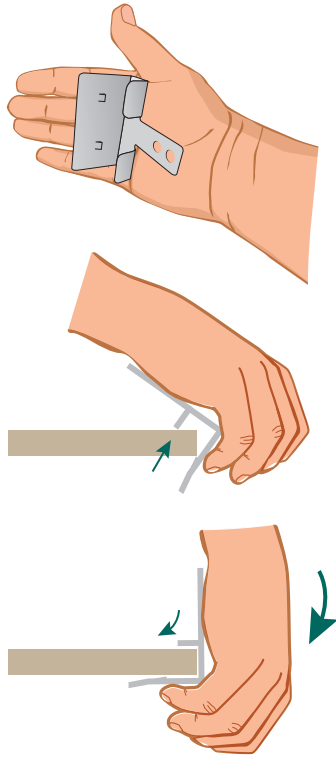

**B** The drywall is placed in position adjacent to the wall or ceiling corner and the fastening tab is attached to the structural framing through a punched hole in the fastening tab with one fastener, either with drywall nail or No. 6 by 1-1/4" - long drywall screw. (Type W or S)

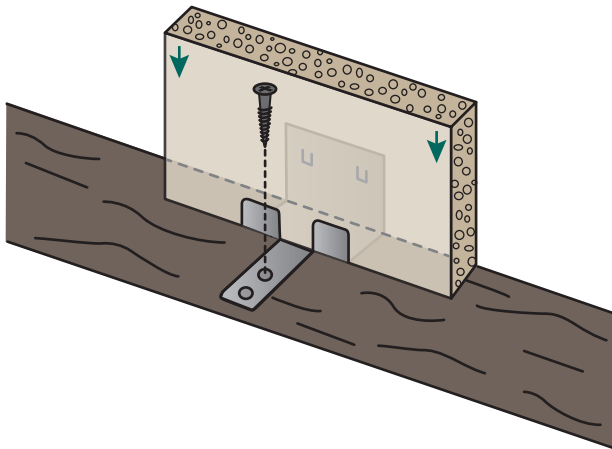

**C** The adjacent drywall is placed against the installed drywall and connected to the structural framing.

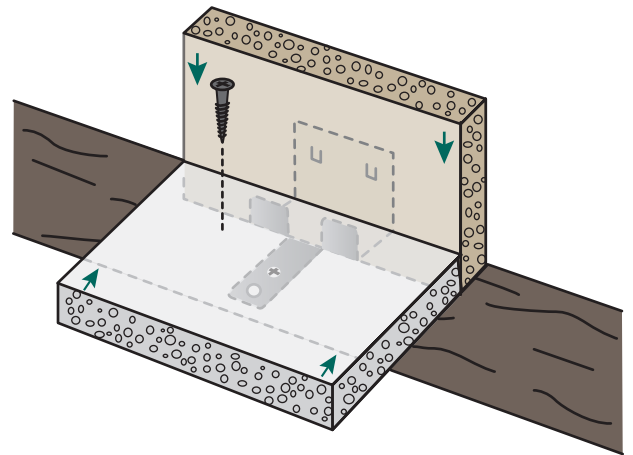

[sales@bmp-group.com](mailto:sales@bmp-group.com) | [www.bmp-group.com](http://www.bmp-group.com)

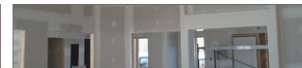

**BAILEY**  
METAL PRODUCTS LIMITED

**MONTREAL**  
800-263-3455

**TORONTO**  
800-668-2154

**CALGARY**  
800-665-2013

**EDMONTON**  
800-563-1751

**VANCOUVER**  
800-818-2666